



LAMILUX CONTINUOUS ROOFLIGHT SYSTEMS

CONTINUOUS DAYLIGHT

CUSTOM-FIT DAYLIGHT AND SAFETY FOR INDUSTRY

"Anyone wishing to achieve top performance in a production hall or warehouse requires an optimal environment and suitable conditions. With this goal in mind, we have developed continuous rooflights that can be customised for every application situation. As systems completely free of thermal bridges, they bring lots of daylight and healthy fresh air into a hall as well as safety in the event of a fire. Getting such optimum performance out of the large roof surfaces is precisely our trade."

Sören Winkler Head of Sales Daylight Systems



The LAMILUX CI Philosophy

Customer value is the reason we exist – and the focus of our activities. This requires harmony, identity and a balance between customer value and company strategy.

The principles that guide our company's actions and customer relations are set out in LAMILUX's company philosophy:

Customized Intelligence – serving customers is our first priority:

This requires outstanding performance and leadership in all areas relevant to customers, particularly in the role of:

- A leader in quality – optimum benefit for customers
- A leader in innovation – at the cutting edge of technology
- A leader in service – fast, uncomplicated, reliable and friendly
- A leader in expertise – optimum sales and technical advisory services
- A leader in solving problems – customised, made-to-order solutions



CONTENT

LAMILUX Continuous Rooflights

Product Description	Page 4
Product Variants	Page 12
Renovation	Page 20
References	Page 22
Ventilation	Page 24
Smoke and Heat Exhaust Ventilation	Page 26
Ventilation Technology	Page 28
Fittings	Page 30

LAMILUX

CONTINUOUS ROOFLIGHTS

Every employee and managing director is grateful for an abundant intake of daylight in industrial halls or warehouses. With regard to buildings with flat roofs, large skylight solutions such as continuous rooflights are especially suitable. They direct healthy daylight into the interior of the building, lower energy costs and serve both as natural ventilation as well as smoke and heat exhaust ventilation (SHEV).

The LAMILUX Continuous Rooflight also provides excellent thermal insulation and is structurally safe even under heavy loads caused by wind and snow. The overall system consists of a number of individual components that are coordinated with each other. This creates innovative and made-to-order skylight solutions – in three variants in fact: the arched Continuous Rooflight B, the even more energy-efficient variant Continuous Rooflight B Passivhaus and the ridged roof design Continuous Rooflight S.



LAMILUX Continuous Rooflight B



LAMILUX Continuous Rooflight S



LAMILUX

CONTINUOUS ROOFLIGHTS



ENERGY EFFICIENCY

Tested and certified heat insulation values (ETA – European technical assessment)

Optimisation of isothermal characteristics and rebate base ventilation as well as minimisation of the condensate risk due to thermal separation on all construction components

Optimal insulating effect and air-tightness for the overall structure, suitable for air-tight shells of buildings (blower door)

Customised intake of daylight and solar heat input thanks to object-specific composite glazing with heat transmission coefficients of up to 1.0 W/(m²K)



FUNCTIONALITY IN EXTREME WEATHER CONDITIONS

Durability thanks to the active expansion absorber as optimal protection of the construction in the event of snow, ice, wind and excessive heat

High level of stability and safety under wind and snow loads thanks to the dynamic torque control in the flaps

Resistance to hail tested as per VKF Bern guidelines and tested watertightness in heavy rain and during storms (DRI 3.0 m²/s)

Impervious to driving rain thanks to welded sealing frames for flap systems and certified airtightness for the overall system



SAFETY

Preventive fire protection according to DIN 18234: Prevention of fire spreading on the roof as a result of the Linear Burn-through Protection

Melt-out of the glazing in the event of a fire to ensure heat extraction

Integration of natural smoke and heat exhaust ventilation devices (NSHEV) and smoke and heat exhaust control systems for smoke removal from the building in the event of a fire

Glazing types that are resistant to flying sparks and radiating heat



ACTIVE EXPANSION ABSORBER

The active expansion absorber ensures a permanently tight, flush joint between the cover strips and the glazing. It also prevents the seals from slipping in the area of the glazing bars – even in the event of wind suction forces and high snow loads.

The active expansion absorber compensates the tension and expansion which occurs when under loads. This is achieved through the continuous, shear-resistant connection between the seals and the cover strips – optimal protection of the construction in the event of snow, ice, wind and excessive heat.



Safety aspects in detail

- + The glazing is watertight and is positively fitted to the cover strips and glazing bars.
- + The cover strips have integrated guide rails for mounting fittings, sun protection devices and maintenance equipment.
- + The clamp is made even safer through an extended adhesive area.

LINEAR BURN-THROUGH PROTECTION

Material components that are perfectly coordinated with each other in the base profile of the continuous rooflight prevent fire from spreading on the roof if there is a fire inside the building – tested as per DIN 18234. Without any need for costly additional measures, such as gravel fill, the Linear Burn-through Protection prevents the "fuse effect" in the vicinity of the skylight opening thereby stopping the flames striking from inside and spreading to the roofing membrane.

In most cases, the roofing membrane, which is attached to a sub-structure such as a frame, is pulled up to the upstand and is fed under the base profile of the Continuous Rooflight. In the event of a fire inside the building, this means that the roofing membrane on the inside of the upstand will catch fire and will tend to burn like a "fuse" to the outside of the roof.

Linear Burn-through Protection can be understood as an intelligent system, which restricts the spread of the fire at the roof penetrations. The base profile of the Continuous Rooflight plays an essential role: It is made of a thermoplastic composite which softens on the upstand in the event of high temperatures and spreads directly over the burning roofing membrane. This process seals the burning joints, cutting off the supply of oxygen and smothering the fire in the area. This prevents burn-through to the roof exterior.



Sophisticated fire protection technology

- + The patented technology prevents fire from spreading onto the roof through roof penetrations in accordance with specifications in DIN 18234 Part 4.
- + The Linear Burn-through Protection renders heavy gravel fills around the continuous rooflight unnecessary.

ISOTHERMAL LOAD CONVERTER

The isothermal load converter channels the load on the continuous rooflight into the supporting structure. Since this frees the base profile from loads and tension, there is no need for any further heat-conducting, metallic components in the base profile.

High-quality composite with very good heat insulation values can therefore be used for the base profile. This achieves optimised isothermal lines running continuously through the construction and prevents thermal bridges.

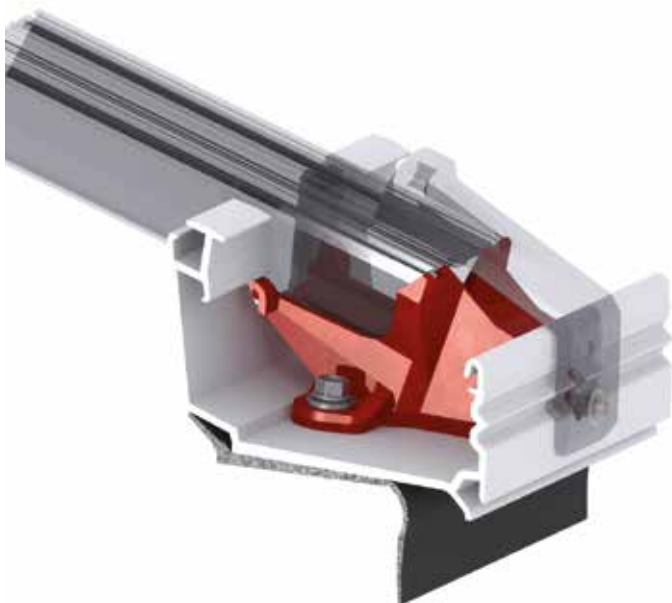

Benefit from optimum energy efficiency

- + The base profile exhibits excellent heat insulation.
- + The risk of condensation is significantly reduced.
- + The rebate base ventilation is optimised.
- + The interior has a smooth appearance thanks to fewer edges which ensures less dirt and grime.

ISOTHERMAL CHARACTERISTICS WITHOUT WEAK SPOTS

We require our products to make the greatest possible contribution to the optimised energy performance of buildings. We give this the utmost consideration in the LAMILUX Continuous Rooflight systems.

Optimised isothermal lines

Isothermal lines describe lines of equal temperature. With regard to LAMILUX Continuous Rooflights, these lines run continuously in the construction. This results in a significantly minimised risk of condensation formation on the inside of the construction.

This is how the isothermal lines are determined and defined

- Standard conditions have been established to quantify the risk of condensation. According to DIN 4108-2 "Thermal insulation and energy economy in buildings", these conditions are: inside temperature of 20 °C, outside temperature of -5 °C, 50% relative humidity.
- Temperatures within the construction can be mapped by what are known as isothermal lines.

- If we adopt the standard conditions, condensate always forms on the inner face of the continuous rooflight if its temperature falls below 10 °C. Condensate leads to a risk of mould and frost and thus potentially causes damage to the building structure.
- The better the Continuous Rooflight structure is, the less cold air is let into the building and the warmer the surface on the inside of the Continuous Rooflight is.
- The course of the 10 °C isothermal line (red line in the diagram) provides information on where condensate can be expected to form on the inside face of the Continuous Rooflight: Namely, wherever the 10 °C isothermal line emerges from the construction. As can be seen in the diagram, the 10 °C isothermal line runs completely within the construction in all LAMILUX Continuous Rooflights.

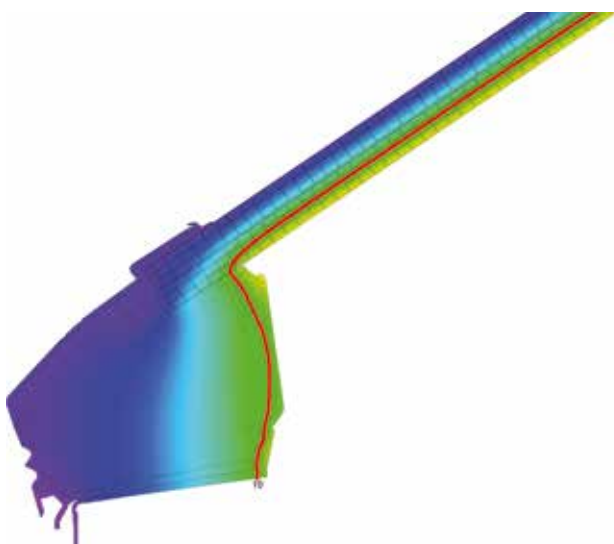

LAMILUX

CONTINUOUS ROOFLIGHT B

Our LAMILUX Continuous Rooflight B is a pioneering daylight system in terms of energy and structure. To be specific, this means: It is an arched, modular skylight system with an optimised energy balance thanks to its complete thermal separation. Optimum smoke removal and ventilation solutions for the property for almost every use case as a result of the extensive range of ventilation and smoke and heat exhaust flaps that can be integrated into the Continuous Rooflight.

The LAMILUX Continuous Rooflight B is optimally suitable for using daylight to provide extensive illumination in halls and for using as an extensive heat exhaust system with melt-out glazing types in the event of a fire. The system is optimised for use as an inexpensive solution in industrial halls and warehouses as standard, but can also be manufactured for installation in sports halls and sales outlets by using glazing with improved heat insulation properties, for example.

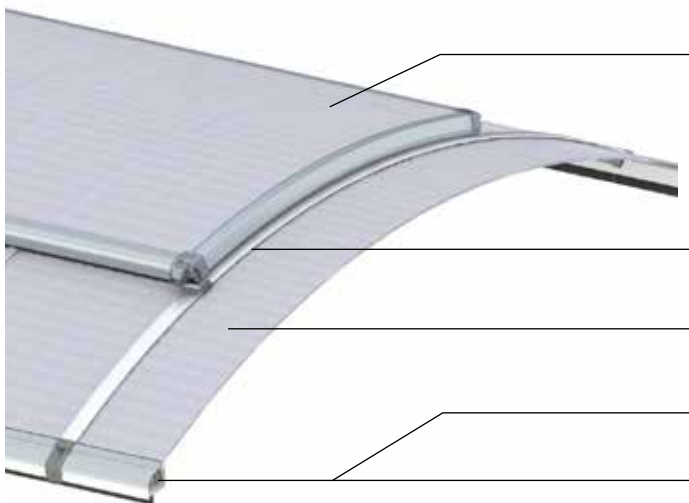

Arched flap as ventilation or qualified smoke and heat exhaust ventilation **with optimised U_f values**, excellent thermal separation and perfected flap adjustment system

Tension bar with active expansion absorber

Wide range of variants for polycarbonate glazing for every use case

Isothermal Load Converter

Base profile: Effective prevention of fire spreading on the roof as per DIN 18234



LAMILUX

CONTINUOUS ROOFLIGHT B PASSIVHAUS

Anyone also wishing to build large hall complexes in an especially energy-efficient manner is making a good decision with our Passivhaus-certified Continuous Rooflight. The overall system has a heat transmission coefficient of only 0.95 W/(m²/K). This enables an overall construction free of thermal bridges with flawless isothermal lines.

Metallic components on the inside and outside are completely thermally separated from each other. The isothermal load converter enables the use of materials with excellent heat insulation properties in the base, while the additional glazing also contributes to the considerable heat insulation properties of the overall system. This makes it the first Continuous Rooflight system in the world to be certified to the Passivhaus standard.



Passivhaus-appropriate polycarbonate glazing

Thermally optimised base profile



LAMILUX

CONTINUOUS ROOFLIGHT S

The LAMILUX Continuous Rooflight S is a modular, ridged roof Continuous Rooflight system and can be fitted with a range of composite glazing types according to requirements. Its completely thermally separated profile system ensures optimum thermal protection and minimises the risk of condensation on the construction's surfaces compared with conventional, non-thermally separated structures.

Combined with the frame system, which has been optimised for the construction, ideally matched solutions are possible without additional upstands provided by the client. Optimum smoke removal and ventilation/aeration solutions for the property for almost every use case as a result of ventilation and smoke and heat exhaust flaps that can be integrated.

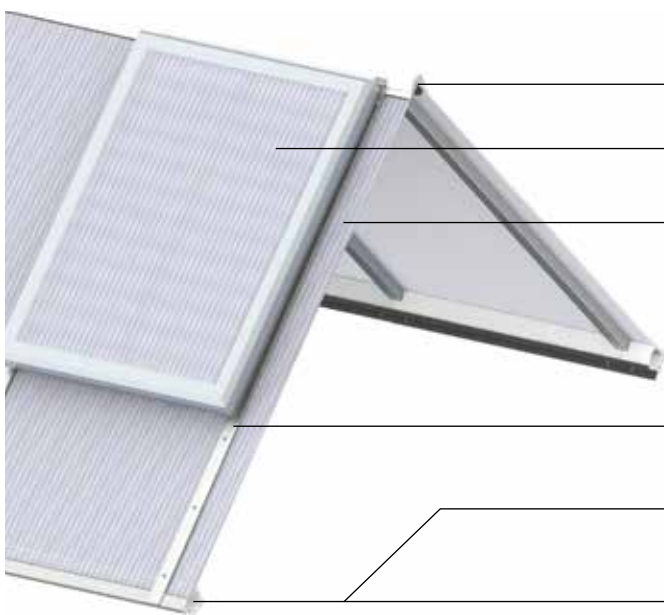

Ridge cover profile

Flap as ventilation or certified smoke and heat exhaust ventilation

Wide range of variants for polycarbonate glazing for every use case

Tension bar with active expansion absorber

Isothermal Load Converter

Base profile: Effective prevention of fire spreading on the roof as per DIN 18234



FLEXIBILITY IN MODERN CONSTRUCTION AND RENOVATION

Energy efficiency and modern design as well as the use of sustainable construction elements dominate the new construction and renovation of industrial halls, warehouses and exhibition halls. Architectural flexibility in aesthetic and functional planning is offered by the three variants of the LAMILUX Continuous Rooflight S.



LAMILUX Continuous Rooflight S 30°

The Continuous Rooflight ridged design features a 30 degree inclination at the base. This variant blends perfectly into the roofscape. This Continuous Rooflight offers many variations for integrating the modular, combinable flap systems for SHEV and ventilation. The LAMILUX Continuous Rooflight S 30° can be built up to a width of six metres.



LAMILUX Continuous Rooflight S 45°

The 45 degree variant of the ridged roof offers great flexibility for integrating SHEV devices. The steeper design creates a larger area for installing flap systems and, consequently, a greater smoke extraction area. The LAMILUX Continuous Rooflight S 45° can be built up to a width of 4.75 metres.



LAMILUX Continuous Rooflight S Shed

The shed-roof design of the Continuous Rooflight, with an inclination angle of 30 and 60 degrees, makes it possible to integrate photovoltaic systems. Photovoltaic modules can be mounted on the broad shed rear thanks to the highly stable supporting structure. The LAMILUX Continuous Rooflight S Shed can be built up to a width of four metres.

DYNAMIC TENSIONING TECHNOLOGY

The dynamic tensioning technology is a structural design principle in the ridged section of Continuous Rooflight constructions with a ridged roof design. It provides flexible force/tension compensation in the event of heavy loads on the overall construction. The technology is based on nature's ability to create integrative form and function.

In areas which consist of several materials in a hybrid construction, there are ridged, elastic and semi-elastic sections in the ridge. In addition to clamps and static latches, the components are also connected by friction fasteners, for example. The result is a lasting elastic and positive locking construction. In the event of vertical and horizontal compressive and tensile loads, the components are prevented from drifting apart or pushing together excessively with the result that they remain connected within defined movement and displacement boundaries. The Continuous Rooflight system will remain torsion-resistant and therefore watertight and secure even in the event of high wind and snow loads.



Flexible force/tension compensation

- + The ridged section is positively connected by means of rigid, elastic and semi-elastic zones.
- + The design principle is bionic thanks to integrative form and function.
- + The Continuous Rooflight system can withstand very strong wind and snow loads.

RENOVATION OF CONTINUOUS ROOFLIGHT SYSTEMS

This is what renovation of continuous rooflight systems with LAMILUX means for you: All processes run smoothly and primarily have a single focus: Comprehensive and optimum service for the customer – from planning to installation, all from a single source. To this end, we record all the requisite parameters involved in the renovation using a detailed checklist before putting the clearly regulated steps into practice by the given deadline.

We have been renovating daylight systems throughout Europe in this way for decades. You benefit from this experience, from our product diversity and our focus on customer-specific projects. For it is our goal to develop and implement a technically impressive, innovative, sophisticated and, at the same time, cost-efficient solution for you.



Renovation example: Wegmann Grundbesitz GmbH, Kassel

Before the renovation

The old shed roofs were renovated with modern arched rooflights. This improved both the climate and energy conditions in the hall as well as the top view.

After the renovation

- Twelve LAMILUX Continuous Rooflights B with thermally separated frame profiles in an insulation chamber
- Restriction of fire spreading as per the requirements of DIN 18234 by means of an integrated safety package with Linear Burn-through Protection
- Twelve Smoke Lifts Continuous Rooflight B as smoke and heat exhaust ventilation devices and an opener for an additional ventilation function





MAN, MUNICH

Project:

Renovation of the roof surface of a production facility belonging to the car manufacturer.

Systems:

- 24 LAMILUX Continuous Rooflights B with varying lengths of 45, 35, 32 and 29 metres
- Equipped with fall-through protection LAMILUX Safety Stripes
- 48 LAMILUX Smoke Lifts Continuous Rooflight B as asymmetric double flaps

ALPLA WERKE, MOSCOW

Project:

Assembly of LAMILUX Continuous Rooflights at all of the composite packaging manufacturer's Russian plants. Renovation of an old industrial building from the Soviet Union era with different roof system.

Systems:

- Ten LAMILUX Continuous Rooflights B with different lengths ranging from six to 66 metres
- Four LAMILUX Smoke Lifts Continuous Rooflight B for ventilation/aeration as well as smoke and heat exhaust ventilation in the event of a fire

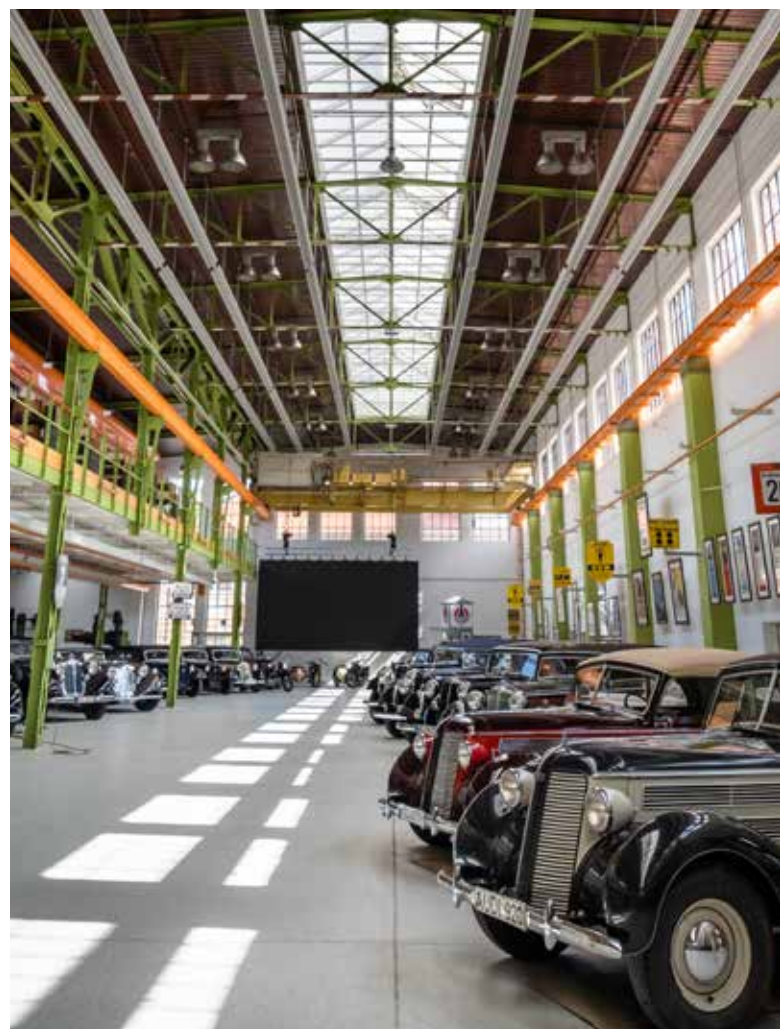

MENNEKES, KIRCHHUNDEM IN SAUERLAND

Project:

New construction of a production hall for electronic components. Special emphasis on high intake of daylight with medium light intensity and anti glare at the same time. Implementation of the fire protection concept.

Systems:

- Three LAMILUX Continuous Rooflights S 30° with fall-through protection grid
- 17 LAMILUX Smoke Lifts Continuous Rooflight S
- Seven LAMILUX Continuous Rooflights B with Safety Stripes
- Seven LAMILUX Ventilation Flaps Continuous Rooflight B
- Seven LAMILUX Smoke Lifts Continuous Rooflight B
- Pneumatic fair weather ventilation
- Light absorption via glass-fibre reinforced composite panels attached to one side
- Four LAMILUX Rooflights F100 with fall-through protection grids

EVENTS HALL, WURZEN

Project:

Renovation and conversion of a former production hall into an events hall.

Systems:

- 21 LAMILUX Continuous Rooflights S 30° with lengths of up to 28 metres
- Eight LAMILUX Smoke Lifts Continuous Rooflight S

NATURAL VENTILATION AND AERATION

Daylight is one thing, fresh air is the other you gain with a Continuous Rooflight. Flap systems with automated actuation that can be integrated make a considerable and economically attractive contribution to an optimal building climate. Like the construction itself, they are thermally decoupled and, together with their welded sealing frame, they provide a compact, closed sealing layer.

The flap systems can be combined in various ways to create ideally dimensioned opening areas as per the property-specific requirements. Fair weather ventilation and night-time cooling can also be automatically mapped in the control matrix: With an additional wind and rain sensor set as well as other control components.



LAMILUX Ventilation Flap Continuous Rooflight B



LAMILUX Ventilation Flap Continuous Rooflight S

DYNAMIC TORQUE CONTROL

Another innovative component in the construction of LAMILUX Continuous Rooflights – dynamic torque control – optimises the tension of the glazing in the flap systems and ensures that the glazing is firmly secured. This results in a high level of stability in the event of wind loads.

Integrated suspension beneath the glazing bead in the mounting frame ensures that the glazing is secured in position by a specific holding force even when subjected to load. In this way, the glazing remains tension-optimised in all situations. As a result, the acting loads are optimally cushioned and absorbed by the mounting frame.



Protection in the event of heavy wind loads

- + The flaps have a high level of stability even when they are open.
- + The anchorage of the polycarbonate glazing is optimised.
- + Spring-mounted multiple-joint traverses provide additional protection for the flap systems.

LAMILUX







SMOKE LIFT CONTINUOUS ROOFLIGHT B & S

In the event of a fire, smoke levels in escape routes must be kept low for as long as possible. LAMILUX Smoke Lifts Continuous Rooflight B and S with standard-compliant triggering achieve this thanks to their effective smoke vent effect. This allows people to escape from inside the building and allows the fire brigade to enter it to extinguish the fire. In their function as natural smoke and heat exhaust ventilation devices, LAMILUX Smoke Lift Continuous Rooflight B and S meet all requirements of DIN EN 12101-2.

Our flap systems enable large, aerodynamic smoke extraction areas and extensive full ventilation. With large dimensions, the flaps of the smoke lift also prove to be an extremely stable overall system when subjected to strong wind loads – even when they are open. In the event of a fire, flaps are quickly opened thanks to thermal release or CO₂ remote release or electric remote release. If additional opening drives are used, our NSHEVs can be used for daily aeration and ventilation.

Temperature parameters according to DIN EN 12101-2 and test results

Our NSHEVs reliably open into the SHEV position in less than 60 seconds...

	... and ensure high smoke discharge volumes	Flow rate coefficient C_v between 0.50 and 0.77 Aerodynamically effective opening area A_a of between 0.59 m ² and 7.40 m ² *
	... after endurance test (1,000 times in SHEV position and 10,000 times in ventilation position)	RE 1000 Ventilation 10,000
	...under snow load	SL 200 to SL 1100
	... in indoor temperatures as low as -5 °C	Continuous Rooflight B: up to T(-25) Continuous Rooflight S: T(-5)
	... after exposure to wind suction (up to 3,000 N/m ²)	WL 1500 to WL 3000
	...when exposed to fire	B 300

How your benefit

- No spreading of flames as the patented Linear Burn-through Protection ensures compliance with DIN 18234, even with no gravel fill
- Excellent heat insulation values without thermal bridges
- Suitable as a “melttable” roof surface pursuant to DIN 18230
- On request, ‘hard roofing’ as per DIN 4102-7: Resistant to flying sparks and radiating heat
- CO₂ cartridges in the NSHEV are not damaged during manual triggering and maintenance
- Many flap combinations – the perfect solution for every need

* applies to Smoke Lift Continuous Rooflight S of 0.32 m² to 6.50 m²



VENTILATION TECHNOLOGY WITH RODA

roda Licht- und Lufttechnik GmbH has been part of the LAMILUX Group since January 2018. The subsidiary's product portfolio covers four core competences: smoke and heat exhaust ventilation, industrial ventilation, daylight technology and translucent facade technology. roda takes care of all project planning up to on-site acceptance. In addition, roda offers maintenance for SHEV systems of all manufacturers as well as renovations within the scope of the four stated core competences.

LAMILUX and roda work together very closely in both development and sales. The benefit for you as a customer: One central contact, no interfaces, larger product portfolio and volume of services.

The first collaborative product is a thermally separated continuous rooflight with rainproof ventilation: The connection between the LAMILUX Continuous Rooflight B and the MEGAPHÖNIX double flap from roda. The element guarantees all-weather ventilation through its weather-resistant side opening flaps. These open automatically as soon as the top-mounted flaps closes when it begins to rain.

The MEGAPHÖNIX can be mounted directly on the continuous rooflight frame with a continuous rooflight width of up to three metres. From a continuous rooflight width of more than three metres, the MEGAPHÖNIX is mounted as a "rider" directly on the glazing bars of the continuous rooflight without interruptions.

A further collaborative solution is the integration of roda's louvered ventilators into the LAMILUX Continuous Rooflight S.

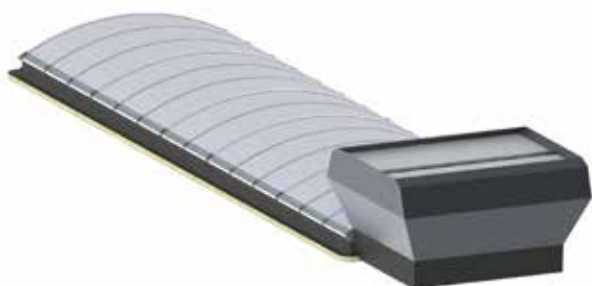

roda MEGAPHÖNIX on the frame of the LAMILUX Continuous Rooflight B



roda MEGAPHÖNIX on the glazing bar of the LAMILUX Continuous Rooflight B



SOLUTIONS FOR OPTIMUM STRUCTURAL ATTACHMENT

Roof mounting options include mounting on steel sheeting upstands, on wooden trusses or reinforced concrete upstand beams. We always adapt our Continuous Rooflight systems to local structural conditions on an individual basis. We will be happy to give you comprehensive advice in this regard.

Stability is of primary concern with our own sheet steel upstands. LAMILUX complies with the requirements of the German Institute for Building Technology (Deutsches Institut für Bautechnik), according to which sheet steel upstands must be manufactured using high steel grades S 280 GD + Z 275 or S 320 GD + Z 275.

Installation on steel sheet upstand



Installation on wooden trusses



Installation on concrete upstand

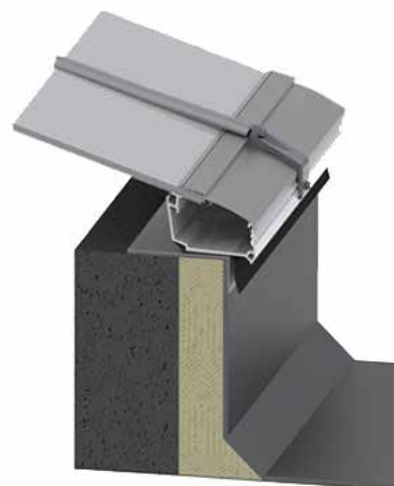

NOTE: The mounting systems shown in the diagrams are concept drawings for guidance purposes only. The roofing specialist must comply with the applicable professional rules of the roofing trade and standards when planning and carrying out waterproofing work.

GLAZING MADE OF GLASS-FIBRE REINFORCED COMPOSITE – GRP

Every LAMILUX Continuous Rooflight comes with the optimum glazing for its intended location on the roof. Alongside traditional solutions, there are also options for special energy efficiency, sound and hail protection as well as special corrosion-resistant variants. Sun protect glazing types are also possible for some of these variants. As is the hard roofing variation which is resistant to flying sparks and radiating heat.

Glazing made of glass fibre-reinforced polyester is especially resistant. Thanks to special material properties, it also manages to hold fast in the event of strong UV radiation and weathering. This glazing was developed for production areas with heightened requirements vis-à-vis the corrosion resistance of installed components. The reason for this could be chemically aggressive emissions from evaporating cooling lubricants in machining, for example. Brittleness or cracks, which chemically aggressive materials could cause in polycarbonates, also do not occur in the material in the long term.

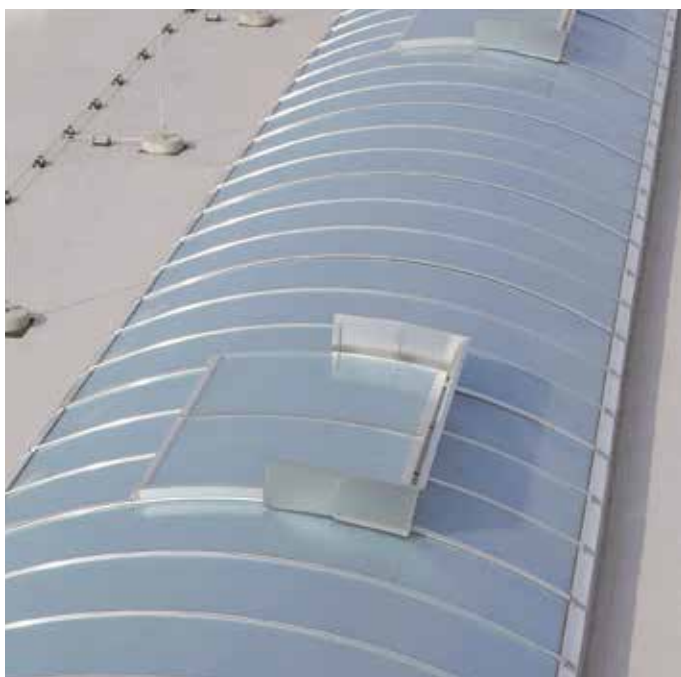

Glazing made of glass-fibre reinforced composite – GRP

- + The glazing is highly resistant to UV radiation and weathering.
- + Increased resistance to chemically aggressive emissions.

Glazing types: Continuous Rooflight B

Standard



PC10-4

U _g value	2.5 W/(m ² K)
Sound-proofing value	17 dB
Fire behaviour	B-s1, d0
Translucency	Approx. 61 %



PC10-4 + PC6-4

U _g value	1.8 W/(m ² K)
Sound-proofing value	18 dB
Fire behaviour	B-s1, d0
Translucency	Approx. 44 %



PC10-4 + PC10-4

U _g value	1.6 W/(m ² K)
Sound-proofing value	19 dB
Fire behaviour	E-d0
Translucency	Approx. 39 %

Energy efficiency



PC10-4 + PC6-4 thermal composite 16

U _g value	1.4 W/(m ² K)
Sound-proofing value	17 dB
Fire behaviour	B-s1, d0
Translucency	Approx. 44 %

Thermal Composite 32 mm is LAMILUX's own development! This glazing offers low flammability combined with excellent thermal insulation.



PC10-4 + PC10-4 thermal composite 16

U _g value	1.2 W/(m ² K)
Sound-proofing value	18 dB
Fire behaviour	E-d0
Translucency	Approx. 39 %



PC10-4 + PC 6-4 + PC10-4 2x tc 5

U _g value	1.0 W/(m ² K)
Sound-proofing value	18 dB
Fire behaviour	E-d0
Translucency	Approx. 27 %

Sound insulation



16 mm soundproof glazing 27dB

U _g value	2.3 W/(m ² K)
Sound-proofing value	27 dB
Fire behaviour	E-d0
Translucency	Approx. 54 %



20 mm soundproof glazing 24dB

U _g value	1.8 W/(m ² K)
Sound-proofing value	24 dB
Fire behaviour	E-d0
Translucency	Approx. 39 %



36 mm soundproof glazing 24dB

U _g value	1.3 W/(m ² K)
Sound-proofing value	24 dB
Fire behaviour	E-d0
Translucency	Approx. 39 %

Corrosion resistance*



20 mm GRP Composite

U _g value	1.8 W/(m ² K)
Sound-proofing value	20 dB
Fire behaviour	E-d0
Translucency	Approx. 31 %

Our glazing types are also available as sun protect or hard roofing on request.

* see page 31

Glazing types: Continuous Rooflight S

Standard



PC10-4

U _g value	2.5 W/(m ² K)
Sound-proofing value	17 dB
Fire behaviour	B-s1, d0
Translucency	Approx. 61 %

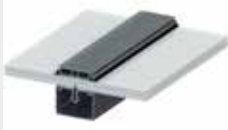

PC10-4 + PC6-4

U _g value	1.8 W/(m ² K)
Sound-proofing value	18 dB
Fire behaviour	B-s1, d0
Translucency	Approx. 44 %

Energy efficiency



PC10-4 + PC6-4 thermal composite 16

U _g value	1.4 W/(m ² K)
Sound-proofing value	17 dB
Fire behaviour	B-s1, d0
Translucency	Approx. 44 %



PC32-5

U _g value	1.2 W/(m ² K)
Sound-proofing value	18 dB
Fire behaviour	B-s1, d0
Translucency	Approx. 32 %

Sound insulation



16 mm soundproof glazing 27dB

U _g value	2.3 W/(m ² K)
Sound-proofing value	27 dB
Fire behaviour	E-d0
Translucency	Approx. 54 %

Corrosion resistance*



32 mm GRP Composite

U _g value	1.3 W/(m ² K)
Sound-proofing value	17 dB
Fire behaviour	E-d0
Translucency	Approx. 26 %

Our glazing types are also available as sun protect or hard roofing on request.

"Hard roofing"



The Continuous Rooflight B and S glazing meets the conditions for "hard roofing" and "melt-out area" (DIN 18230-1) at the same time – or comply with these two characteristics separately. It thus fulfils the DIN 13501-5 requirements for resistance to flying sparks and radiated heat – as confirmed by MFPA Leipzig GmbH.

Accessories

Fall-through protection grating

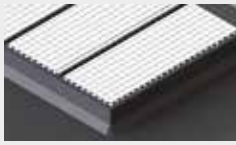

Fall-through protection grids are permanently fall-through proof in compliance with GS-Bau 18 for clear upturn widths of between 0.80 metres and 6.00 metres. The grid is fastened to specially manufactured stainless steel retaining plates, which in turn are screwed onto the supporting structure, e.g. sheet steel frame or wooden upstand.

LAMILUX Safety Stripes

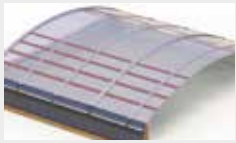

LAMILUX Safety Stripes are fastened directly to the support profiles of the continuous rooflight. With a discreet visual appearance, they offer permanent fall-through protection as per GS-Bau 18 even before the glazing is mounted. Filigree laser grids are used in the flap area. These ensure reliable fall-through protection even when the flaps are open, e.g. during maintenance work.

Sun protection



A metal screen coated in the RAL colour you require and featuring a deciduous tree effect for natural shade. Deciduous tree effect screens fulfil GS-Bau 18 requirements with regard to continuous fall-through protection. The perforated steel sheet also provides protection against hail and incidental UV light.

Insect protection grating

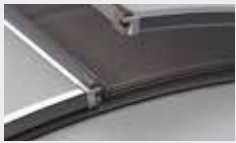

The insect protection grid is integrated into the flap systems. No insects can enter the building interior when the flaps are open.

Gable wall ventilator



All ventilators have an electric cover flap. Installation is dependent on some parameters, such as the Continuous Rooflight width and the installation position.

Smoke seal



The smoke seal consists of an internal polycarbonate sheet and external aluminium plates. It is used for the compartmentalisation of fire sections whereby the polycarbonate of the Continuous Rooflight glazing melts and the smoke seal further restricts the fire section.

Anchor point for PPE



The anchor point for PPE is mounted on LAMILUX Continuous Rooflight frames prepared for such purposes and serves as an anchor point for personal protective equipment to prevent falls. It is an anchor point for using a carabiner in conjunction with a safety harness (EN 361) and fall arrest system (EN 363). No more than three persons are permitted to attach themselves to the rotatable anchorage eye.

Other available features: Installation opening, roof exit hatch, blind connection, RAL colouring for the profiles

Comfort and safety

Opener variants



Pneumatic cylinder

- Lift heights: 300 mm, 500 mm, 700 mm



24 volt sliding shaft drive

- SHEV
- Daily ventilation



230 volt sliding shaft drive

- Voltage: 230 volt
- Lift heights: 300 mm, 500 mm, 750 mm



Chain drive

- Voltage: 24 volt, 230 volt
- Lift heights: 300 mm, 500 mm

Flap combinations

All smoke lift systems can be integrated as a single flap or as opposing double flaps. Similarly, it is possible to combine two flaps by arranging them directly next to each other. This flap combination acts as a natural smoke and heat exhaust ventilation device with a higher aerodynamic smoke extraction area, which is referred to as a tandem-serial single or double flap.

LAMILUX Smoke Lift Continuous Rooflight B

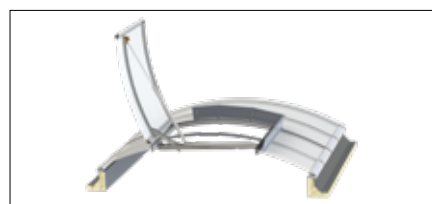

As single flap



As asymmetric double flap

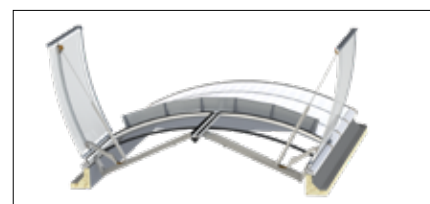

As symmetric double flap

LAMILUX Smoke Lift Continuous Rooflight S



As single flap



As double flap

Available flap sizes

LAMILUX Smoke Lift Continuous Rooflight B

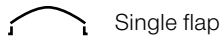

Single flap

Can be used from Continuous Rooflight width in cm	Width in cm	Length in cm	Geometrically unobstructed opening area A_{geo} in m^2	Aerodynamically effective opening area A_a in m^2
100	98	96	0.93	0.59
100	98	201	1.96	1.27
100 TS	98	201	1.96	1.23
100 TS	98	411	4.01	2.53
125	123	96	1.17	0.74
125	123	201	2.46	1.60
125 TS	123	201	2.46	1.53
125 TS	123	411	5.04	3.18
150	150	96	1.43	0.90
150	150	201	3.01	1.96
150 TS	150	201	3.02	1.87
150 TS	150	411	6.17	3.83

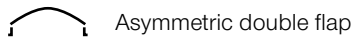

Asymmetric double flap

Can be used from Continuous Rooflight width in cm	Width in cm	Length in cm	Geometrically unobstructed opening area A_{geo} in m^2	Aerodynamically effective opening area A_a in m^2
175	175	96	1.67	1.04
175	175	201	3.51	2.28
175 TS	175	201	3.52	2.18
175 TS	175	411	7.20	4.68
200	200	96	1.91	1.18
200	200	201	4.01	2.61
200 TS	200	201	4.02	2.53
200 TS	200	411	8.22	5.34

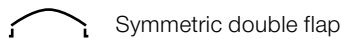

Symmetric double flap

Can be used from Continuous Rooflight width in cm	Width in cm	Length in cm	Geometrically unobstructed opening area A_{geo} in m^2	Aerodynamically effective opening area A_a in m^2
250	250	96	2.39	1.48
250	250	201	5.02	3.26
250 TS	250	201	5.03	3.12
250 TS	250	411	10.28	6.37
300	300	96	2.87	1.78
300	300	201	6.02	3.91
300 TS	300	201	6.04	3.74
300 TS	300	411	12.34	7.40

LAMILUX Smoke Lift Continuous Rooflight S

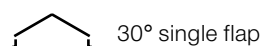

Can be used from Continuous Rooflight width in cm	Width in cm	Length in cm	Geometrically unobstructed opening area A_{geo} in m ²	Aerodynamically effective opening area A_a in m ²
100	53	100	0.53	0.32
100	53	205	1.09	0.64
100 TS	53	206	1.09	0.63
100 TS	53	416	2.20	1.19
150	82	100	0.82	0.49
150	82	205	1.68	0.99
150 TS	82	206	1.69	0.98
150 TS	82	416	3.41	1.81
200	111	100	1.11	0.64
200	111	205	2.28	1.30
200 TS	111	206	2.28	1.30
200 TS	111	416	4.62	2.45
250	140	100	1.40	0.80
250	140	205	2.87	1.61
250 TS	140	206	2.88	1.55
250 TS	140	416	5.82	2.97
300	169	100	1.69	0.95
300 TS	169	206	3.47	1.84

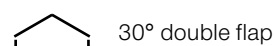

Can be used from Continuous Rooflight width in cm	Width in cm	Length in cm	Geometrically unobstructed opening area A_{geo} in m ²	Aerodynamically effective opening area A_a in m ²
100	102	100	1.02	0.64
100	102	205	2.09	1.28
100 TS	102	206	2.10	1.24
100 TS	102	416	4.24	2.42
150	152	100	1.52	0.96
150	152	205	3.12	1.90
150 TS	152	206	3.13	1.84
150 TS	152	416	6.32	3.48
200	202	100	2.02	1.25
200	202	205	4.14	2.57
200 TS	202	206	4.15	2.53
200 TS	202	416	8.40	4.96
250	252	100	2.52	1.54
250	252	205	5.17	3.20
250 TS	252	206	5.18	3.21
250 TS	252	416	10.48	6.50
300	302	100	3.02	1.84
300 TS	302	206	6.21	3.85

Available flap sizes

LAMILUX Smoke Lift Continuous Rooflight S

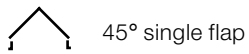

Can be used from Continuous Rooflight width in cm	Width in cm	Length in cm	Geometrically unobstructed opening area A_{geo} in m ²	Aerodynamically effective opening area A_a in m ²
80	53	100	0.53	0.33
80	53	205	1.09	0.65
80 TS	53	206	1.09	0.65
80 TS	53	416	2.20	1.23
120	82	100	0.82	0.51
120	82	205	1.68	0.99
120 TS	82	206	1.69	1.01
120 TS	82	416	3.41	1.91
160	111	100	1.11	0.67
160	111	205	2.28	1.32
160 TS	111	206	2.28	1.30
160 TS	111	416	4.62	2.45
200	140	100	1.40	0.80
200	140	205	2.87	1.64
200 TS	140	206	2.88	1.55
200 TS	140	416	5.82	2.97
240	169	100	1.69	0.96
240 TS	169	206	3.47	1.84

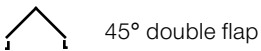

Can be used from Continuous Rooflight width in cm	Width in cm	Length in cm	Geometrically unobstructed opening area A_{geo} in m ²	Aerodynamically effective opening area A_a in m ²
120	122	100	1.22	0.94
120	122	205	2.49	1.84
120 TS	122	206	2.50	1.82
120 TS	122	416	5.05	3.54
160	163	100	1.63	1.25
160	163	205	3.33	2.47
160 TS	163	206	3.34	2.44
160 TS	163	416	6.76	4.39
200	204	100	2.04	1.51
200	204	205	4.17	2.71
200 TS	204	206	4.18	2.59
200 TS	204	416	8.47	5.08
240	245	100	2.45	1.71
240 TS	245	206	5.03	3.02

LAMILUX Smoke Lift Continuous Rooflight S



Can be used from Continuous Rooflight width in cm	Width in cm	Length in cm	Geometrically unobstructed opening area A_{geo} in m ²	Aerodynamically effective opening area A_a in m ²
110	53	100	0.53	0.32
110	53	205	1.09	0.64
110 TS	53	206	1.09	0.62
110 TS	53	416	2.20	1.21
170	82	100	0.82	0.49
170	82	205	1.68	0.99
170 TS	82	206	1.69	0.96
170 TS	82	416	3.41	1.88
230	111	100	1.11	0.65
230	111	205	2.28	1.32
230 TS	111	206	2.28	1.26
230 TS	111	416	4.62	2.49
290	140	100	1.40	0.81
290	140	205	2.87	1.64
290 TS	140	206	2.88	1.55
290 TS	140	416	5.82	3.03
350	169	100	1.69	0.96
350 TS	169	206	3.47	1.84

Quality



German General Technical Approval:

The German General Technical Approval is issued by the German Institute of Building Technology (Deutscher Institut für Bautechnik – DIBt) for all German Federal States. This certificate verifies that a construction product meets the technical requirements for its use.

European Technical Approval – ETA:

An ETA is a recognised certificate valid in EU member states which attests the technical usability of a building product. The test assessment for the LAMILUX Continuous Rooflight B is based on the approval guidelines drawn up by European Organisation for Technical Approval (ETAGs). The approval issued to LAMILUX takes into account all key product features needed to comply with the building regulation requirements in individual EU countries.

Declaration of performance for building products:

The declaration of performance states the performance of building products in relation to the key features of such products in accordance with the relevant harmonised technical specifications.

The LAMILUX certificate of quality – a document regarding your safety:

This document enables us to provide proof to our customers of the excellent quality of the supplied product each time we deliver a system. We thus submit evidence which confirms that our daylight systems are consistently manufactured and implemented in accordance with product approvals and the technical standards specified in the approvals.

Environmental product declarations for all systems:

Environmental Product Declarations are issued as per the requirements of European standard DIN EN 15804 and DIN EN ISO 14025 and are an internationally recognised and accepted product eco-label, because: They make it possible to draw valid conclusions about the environmental impact of a product – from its manufacture, the raw materials used and resource consumption through the product life cycle until its dismantling and disposal.



Scan this to discover more about
LAMILUX daylight systems!



ROOFLIGHT F100



GLASS SKYLIGHT F100



GLASS SKYLIGHT FE

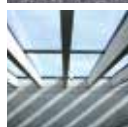

GLASS ARCHITECTURE



RENOVATION

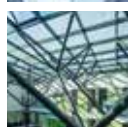

MIROTEC STEEL CONSTRUCTIONS



CONTINUOUS ROOFLIGHT B



CONTINUOUS ROOFLIGHT S



CONTINUOUS ROOFLIGHT W|R



SMOKE AND HEAT EXHAUST
VENTILATION SYSTEMS



BUILDING SMOKE EXTRACTION



RODA LIGHT AND AIR TECHNOLOGY

The technical data printed in this brochure was accurate when this brochure went to press and is subject to change without notice. Our technical specifications are based on calculations and supplier specifications, or have been determined by independent testing authorities within the scope of applicable standards.

Thermal transmission coefficients for our composite glazing were calculated using the finite element method with reference values in accordance with DIN EN 673 for insulated glass. Based on empirical values and specific characteristics of the plastics, a temperature vector of 15 K was defined as the vector between the outer surfaces of the material. Functional values refer to test specimens and the dimensions used in testing only. We cannot provide any further guarantees of technical values. This particularly applies to changes in installation locations, or if dimensions are re-measured on site.



LAMILUX Heinrich Strunz GmbH

Zehstraße 2 · PO Box 1540 · 95111 Rehau

Tel.: +49 (0) 92 83 / 5 95-0 · Fax +49 (0) 92 83 / 5 95-29 0

E-Mail: information@lamilux.de

www.lamilux.com



**Window & Door
Accessories Ltd**

Window and Door Accessories Ltd

Richmond House · Newtown Avenue

Malahide Road Industrial Park · Dublin 17 D17 VA09 · Ireland

Tel.: +353 1 867 0011 · Fax +353 1 867 0013

E-Mail: info@wdacc.ie

www.wdacc.ie

